

Rated Voltage : 12V

Operating Temp : 10~70°C

Protection : Auto-Restart /Impedance

 Material : Housing Plastic (UL : 94V-0)
 Impeller Plastic (UL : 94V-0)

Weight : 28g

Safety Approval



AIR FLOW-AIR PRESSURE(PERFORMANCE CURVES)

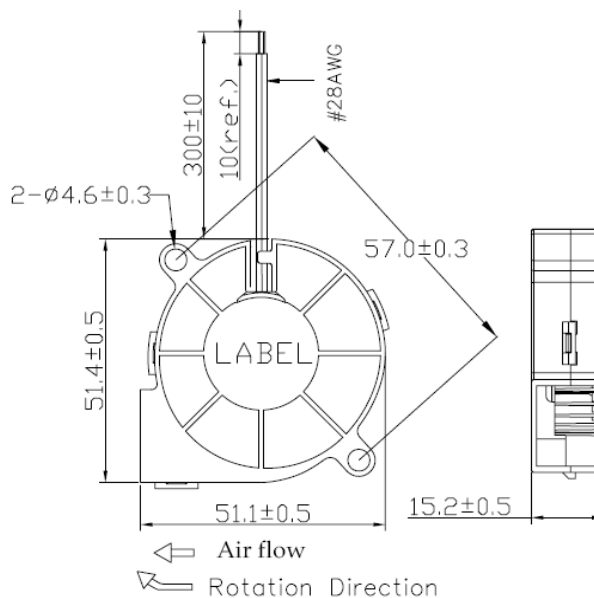
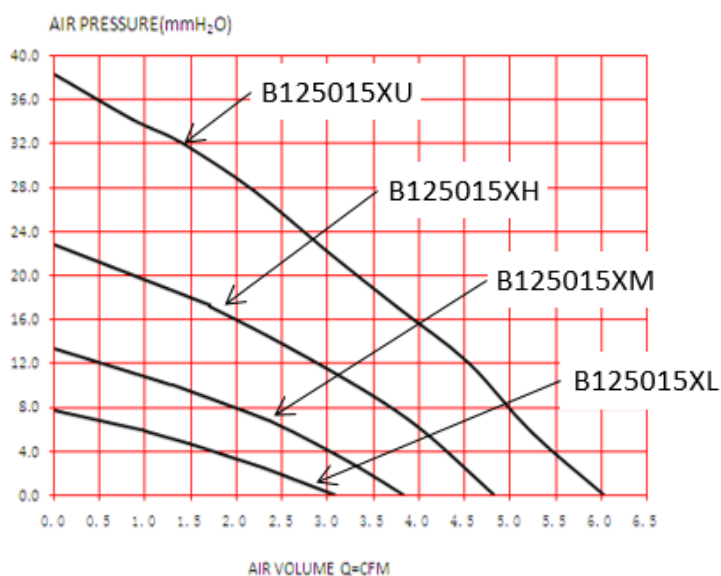

Series	Bearing (*)	Rated Voltage (V)	Rated Current (Amp)	Input Power (W)	Rated Speed (rpm)	Air Flow		Static Pressure (mmH ₂ O)	Noise dB(A)
						(CFM)	m ³ /min		
B125015XL	●	12	0.08	0.96	4500	3.08	0.09	7.7	34.1
B125015XM	●	12	0.11	1.32	5500	3.84	0.11	13.3	40.8
B125015XH	●	12	0.20	2.40	7000	4.83	0.14	22.73	46.5
B125015XU	●	12	0.4	4.80	8500	6.04	0.17	38.34	51.5

*Bearing Type : ○ Sleeve ▲ EBR ● 2 Ball

*Noise measured at the distance of one meter from the axis of intake.

*The latest version would be as per the standard issued by REGO only.